

1

The Clinical Information Management System of the Department of Health

**Dr KWONG Kwok Wai,
Heston**

Assistant Director of Health
(Drugs)

 **Department of Health**
The Government of the Hong Kong Special Administrative Region
24 November 2011

Agenda

2

- Objectives of territory-wide sharing of electronic health records (eHR)
- Development of eHR related components in Department of Health
- Overview of the Clinical Information Management System (CIMS)
- IT Infrastructure of CIMS
- CIMS Application
- CIMS Feature Highlights
 - ✦ Internet Booking
 - ✦ Use of Mobile Devices
 - ✦ Disease Notification
 - ✦ Contact Tracing
 - ✦ Defaulter Tracing
 - ✦ Guided Treatment Protocol
 - ✦ Link to Clinical Photo
 - ✦ Link to Body Chart
 - ✦ e-Form Deployment
 - ✦ Periodontal Chart

Objectives of territory-wide sharing of electronic health records (eHR)

3

- Promote patient-centric care
 - Allowing healthcare service providers to timely acquire essential and comprehensive clinical information of their patients
- Strengthen primary healthcare services
 - Building up lifelong electronic health records for patients
- Facilitate the collaboration between hospitals and primary healthcare service providers
- DH needs to develop eHR related systems complying with eHR interoperability standards to support the Government initiative

Development of eHR related components in DH

4

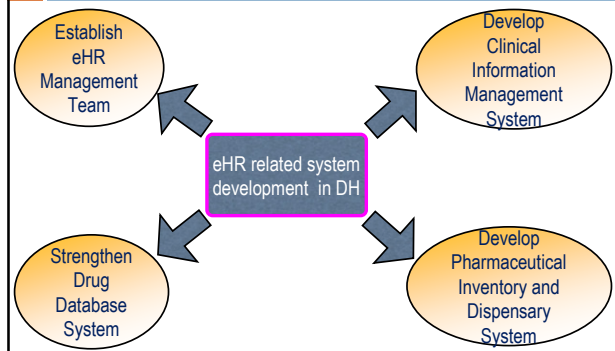

Overview of CIMS - 1

5

- > DH Service units participated in CIMS include:
 - > Families Clinics under Professional Development and Quality Assurance
 - > Social Hygiene Service
 - > Clinical Genetic Service
 - > Antenatal Service under Family Health Service
 - > Dental Service

Overview of CIMS - 2

6

- > Major Common CIMS Modules
 - > Person Master Index
 - > Registration & Appointment
 - > Clinical Content
 - > Investigation
 - > Medication Order Entry
 - > Payment

Overview of CIMS - 3

7

- IT infrastructure for CIMS:
 - a centralised data repository
 - a Service Oriented Architecture (SOA)
 - a dedicated network

- Develop interfaces to connect CIMS to different external systems, including Eligibility Checking System, Laboratory Information System, Pharmaceutical Inventory & Dispensary System and the territory-wide eHR System

Network Infrastructure

IT Infrastructure of CIMS 1

8

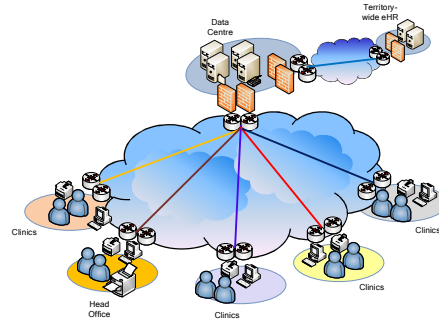

Primary Data Centre

IT Infrastructure of CIMS 2

9

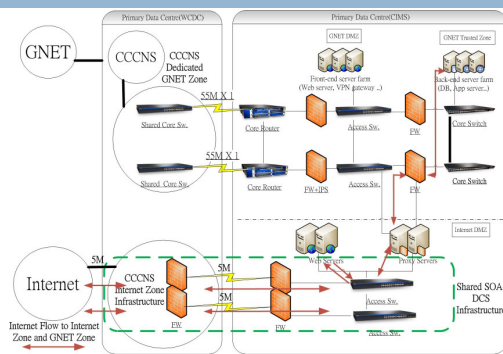

Disaster Recovery Data Centre

IT Infrastructure of CIMS 3

10

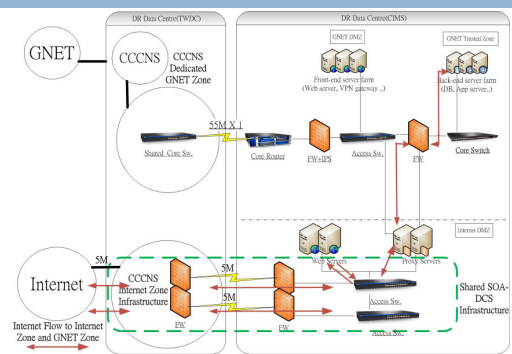

CIMS Software Components

IT Infrastructure of CIMS 4

11

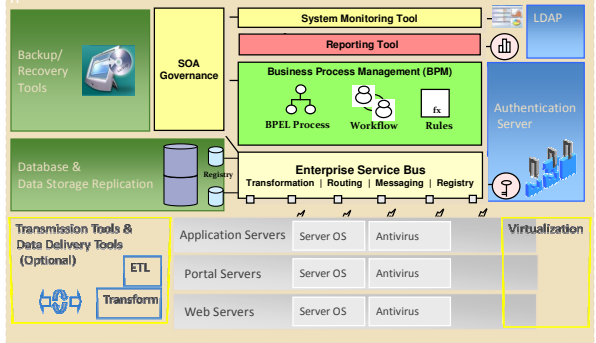

Service Oriented Architecture

IT Infrastructure of CIMS 5

12

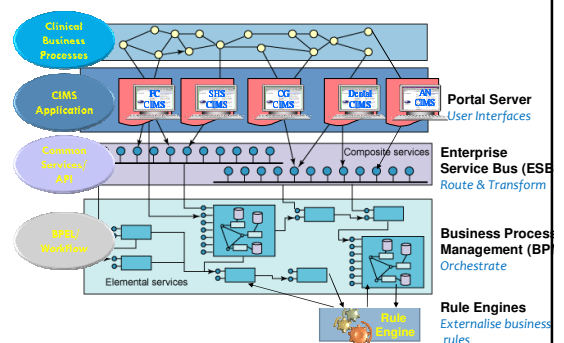

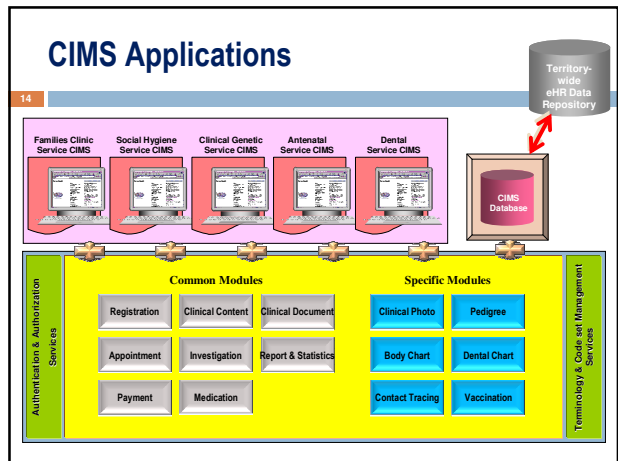
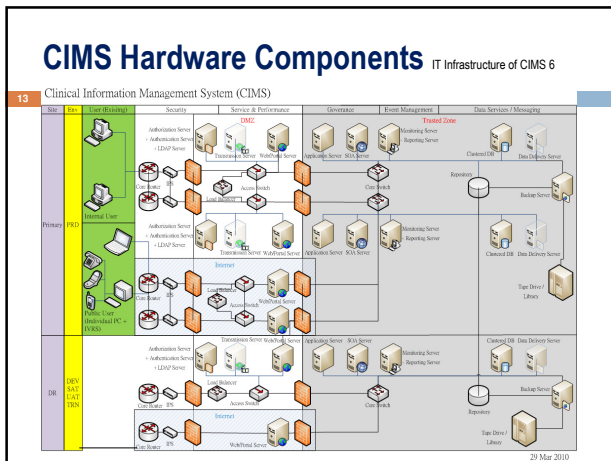

CIMS Feature: Internet Booking - 1

The screenshot shows the GovHK website's online services section. The 'Online Services' menu is expanded to show various categories: Business & Trade, Non-Residents, Communications & Technology, Culture, Leisure & Sports, Education & Training, Employment, Environment, Government, Law & Order, Health & Medical Services, Housing & Social Services, Immigration Services, Taxes & Duties, and Transport & Motoring. A red box highlights the 'Book Clinical Services from Department of Health' link under the Health & Medical Services category.

CIMS Feature: Internet Booking - 2

The screenshot shows the internet booking interface. It includes a header for the Department of Health and a user profile for WONG BING. The main section is titled 'Step 1: Client Information >> Step 2: Book Appointment'. It features a 'Service Selection' dropdown, a 'District Selection' dropdown, and a 'Clinic Selection' dropdown. There are also fields for 'Start searching from' (10:00) and 'Sessions Appointment Time (optional)'. A table lists available time slots with columns for Slot, Clinic, District, Date, Day, and Time. A red box highlights the 'Book' button at the bottom left.

CIMS Feature: Internet Booking - 3

The screenshot shows the appointment confirmation screen. It displays the appointment details for 'NA Hospital' with a booking type of '11-13 weeks for First Trimester Down's Screening'. The appointment date is 22-05-2010 at 09:45. A table lists the client information: CHEUNG PO PO (Client Info) and FLJMC-2010-00123 (Appointment No.). The booking type is '11-13 weeks for First Trimester Down's Screening'. At the bottom, there are buttons for 'Confirm', 'Delete', 'Search Earliest Available', and 'Cancel'. A red box highlights the 'Confirm' button.

CIMS Feature: Internet Booking - 4

The screenshot shows the appointment slip for Wong Wing. It includes the patient's name (王詠), gender (Female), and priority (LXX2100(X)). The appointment date and time are 2010年2月22日 (Monday) at 10:30 AM. The doctor's name is Wong Wing (王詠). The slip includes a barcode and the number 9306567133. The text is in both Chinese and English.

投影片 18

IU2

The name on the appointment slip is different from that in the previous slide.
IBM's User, 10/26/2011

CIMS Feature: Use of mobile devices - 1

- Incorporate Immunisation Record System (IRS) into CIMS
- Mobile devices supports the school operation of School Immunisation Teams (SIT)

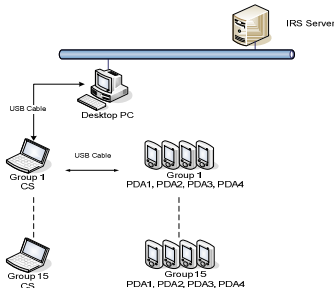

CIMS Feature: Use of mobile devices - 2

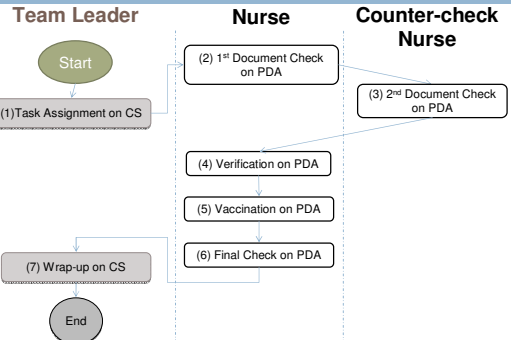

CIMS Feature: Use of mobile devices - 3

(1) Task Assignment on CS

The screenshot shows the 'Department of Health' interface with a 'CIMS RESTRICTED (dev)' login. The user is assigned to '10-02 > WC26'. A table lists vaccination tasks for various classes:

班別	疫苗	人數	學號	狀況	首套人	複套人	分班
1A	DTap-IPV3dTnP-IPVChbV	22	1-22	準備首套	RN 表 (S1)	EN 查 (S2)	分班
1B	DTap-IPV3dTnP-IPVChbV	23	1-23	準備首套	ENO 查 (S2)	RN 表 (S1)	分班
1C	DTap-IPV3dTnP-IPVChbV	22	1-22	準備首套	INO 查	INO 查	分班
1D	DTap-IPV3dTnP-IPVChbV	26	1-26	準備首套	INO 查	INO 查	分班
6A	DTap-IPV3dTnP-IPVChbV	32	1-32	未安排首套人			分班
6B	DTap-IPV3dTnP-IPVChbV	32	1-32	未安排首套人			分班
6C	DTap-IPV3dTnP-IPVChbV	31	1-32	未安排首套人			分班
6D	DTap-IPV3dTnP-IPVChbV	30	1-30	未安排首套人			分班

CIMS Feature: Use of mobile devices - 4

(2) 1st Document Check on PDA

The PDA screen shows the student's details: 02 陳笑文 CHAN SIU MAN (男), 19-08-2003. The record includes vaccination status for DTap-IPV, BCG, and ID# SIT030010301. A barcode is visible on the right side of the screen.

CIMS Feature: Use of mobile devices - 5

注射疫苗

The diagram displays various vaccination records and documents, including:

- DTap-IPV (第一針, 第二針)
- BGV (第一針, 第二針)
- DH6 (DH6影印本)
- R冊
- BCG: Y
- 大陸

CIMS Feature: Use of mobile devices - 6

(3) 2nd Document Check on PDA

(4) Verification on PDA

The first screenshot shows the '2nd Document Check' screen with a red circle around the '核對' (Verify) button. The second screenshot shows the 'Verification' screen with a red circle around the '核對' (Verify) button. The student details are the same as in the previous slide.

投影片 19

IU3 The name on the appointment slip is different from that in the previous slide.
IBM's User, 10/26/2011

投影片 20

IU4 The name on the appointment slip is different from that in the previous slide.
IBM's User, 10/26/2011

投影片 21

IU5 The name on the appointment slip is different from that in the previous slide.
IBM's User, 10/26/2011

投影片 22

IU6 The name on the appointment slip is different from that in the previous slide.
IBM's User, 10/26/2011

投影片 24

IU7 The name on the appointment slip is different from that in the previous slide.
IBM's User, 10/26/2011

投影片 25

IU8 The name on the appointment slip is different from that in the previous slide.
IBM's User, 10/26/2011

投影片 26

IU9 The name on the appointment slip is different from that in the previous slide.
IBM's User, 10/26/2011

CIMS Feature: Contact Tracing - 2

31

Showing the link to the Index

Department of Health
The Government of the Hong Kong Special Administrative Region
CIMS RESTRICTED (DEV)
CMI (SHS)
01-10-1976
A3246973
15:40
User: Dr. Chiu Ka-fai (Dr. Chiu Ka-fai)
Login Time: 15:32:20 2010

Navigation: Home | CMI | SHS | Demographic Info | Encounter | Problem | Procedure | CTR | Past Med Hx | Family Hx | Social Hx | Allergy | Document | Medication

Address, Reaction & Allergies: Used to 12-2010 15:15
Appt: Last Upd: 15-08-2009
Reason of Encounter: History of Present Illness
Physical Examination: Vital Signs
Management: Life
Summary: Menstrual cycle
Menstrual cycle: Menstrual cycle

Assessment: 15-08-2009
Status: Active
New Details: Update
Update Date: 20-10-2010

Problems: 20-10-2010
Name: Last Upd: 20-10-2010
Principal: Gonorrhoea
Status: Active
New Details: Update
Update Date: 20-10-2010

Centers: 03112210 (New)
Laboratory Test: 20-10-2010
Document: 20-10-2010
Follow up: 20-10-2010

Buttons: Save, Task, Read, Cancel

CIMS Feature: Contact Tracing - 3

32

The clinical information of the Index and other sexual partners

Department of Health
The Government of the Hong Kong Special Administrative Region
CIMS RESTRICTED (DEV)
CMI (SHS)
01-10-1976
A3246973
15:40
User: Dr. Chiu Ka-fai (Dr. Chiu Ka-fai)
Login Time: 15:32:20 2010

Navigation: Home | CMI | SHS | Demographic Info | Encounter | Problem | Procedure | CTR | Past Med Hx | Family Hx | Social Hx | Allergy | Document | Medication

Address, Reaction & Allergies: Used to 12-2010 15:15
Appt: Last Upd: 15-08-2009
Reason of Encounter: History of Present Illness
Physical Examination: Vital Signs
Management: Life
Summary: Menstrual cycle
Menstrual cycle: Menstrual cycle

Assessment: 15-08-2009
Status: Active
New Details: Update
Update Date: 20-11-2010

Problems: 20-10-2010
Name: Last Upd: 20-11-2010
Principal: Gonorrhoea
Status: Active
New Details: Update
Update Date: 20-11-2010

Centers: 03112210 (New)
Laboratory Test: 20-11-2010
Document: 20-11-2010
Follow up: 20-11-2010

Buttons: Save, Task, Read, Cancel

CIMS Feature: Defaulter Tracing - 1

33

Set up reminders

Department of Health
The Government of the Hong Kong Special Administrative Region
CIMS RESTRICTED (DEV)
RAM (Social Hygiene)
14:25

Parameter Configuration

Parameter Configuration

Parameter For: Time of triggering reminder for defaulters

Time of triggering reminder for each encounter type

Encounter Type*	STI(New)	hours	before	the end of last day of booked period*
Injection	3	hours	before	the end of last day of booked period*

Buttons: Confirm, Reset

CIMS Feature: Defaulter Tracing - 2

34

Log for recording the communication with client on the reminder

Special Request and Reminder Info. of 8333300000 - WONG KING EAK

Special Request	Tel	Email	SMS	Fax	Mail
	Tel: (2345 8789 / 9876 5432)				

Called Date: [Calendar]

Called Time: [Time]

Caller Name: CHAN TAI MAN

Notes: [Text Area]

Buttons: Confirm, Cancel

CIMS Feature: Defaulter Tracing - 3

35

Print defaulter list

Attendance List

Date: 22 03 2010 to 26 03 2010

Appt. Time Period: [Time] to [Time]

Clients of list: Defaulter Attended Clients

Buttons: Confirm, Cancel

CIMS Feature: Defaulter Tracing - 4

36

Notify colleague(s) to remind patients

Attendance List
22 Mar 2010 - 26 Mar 2010
printed on: 26-03-2010 16:25

	PMH	Patient Name	Telephone	Service ID	Encounter Type
<input type="checkbox"/>	9221235239	WONG YAN 王仁	91234568	SHC-FM-1221	Injection
<input type="checkbox"/>	9333312659	CHAN SIU 陳笑	91237778	SHC-FM-0521	Injection
<input type="checkbox"/>	9173426599	WONG TAI MAN 黃太文	91245612	SHC-FM-1057	Injection
<input type="checkbox"/>	911124511	WONG KIN MING 黃健明	91243332	SHC-FM-1222	Injection
<input type="checkbox"/>	9331245689	LI FUNG 李鳳	91115612	SHC-FM-1654	Injection
<input type="checkbox"/>	9331235689	CHEUNG YI 張怡	91666612	SHC-FM-6521	Injection
<input type="checkbox"/>	9126374599	WONG SIU KUEN 黃小嫻	91277712	SHC-FM-1369	Injection

Buttons: Notify, Print, Cancel

Page 1:1

CIMS Feature: Guided Treatment Protocol

37

Cheung Bo Bo 張寶寶 F, 34, 01-10-1976

Atopic Dermatitis Assessment Form

Severity

- Erythema
- Edema/ population
- Excoriation
- Crusting
- Lichenification
- Xerosis
- Extent
- Pruritus
- Sleep Loss
- Scoriard:
- TIS:

Complications

Triggering

- Contact Irrit
- Contact All
- Infections
- Concurrent
- Stress
- Climate
- Food
- Inhalant all
- Others
- Remarks

TIS Chart

Date	Score
01/04/2009	0
12/12/2009	1
03/02/2009	2
04/04/2009	6
13/09/2009	5
02/12/2009	3
28/02/2009	0
20/05/2009	2
14/09/2010	3

CIMS Feature: Link to Clinical Photo

38

Department of Health
The Government of the Hong Kong Special Administrative Region

9111100001 Cheung Bo Bo 張寶寶

Companion

Adverse Reactions & Allergies

Assessment

Problems

Procedures

Medications

Laboratory Test

Document

Pharmaceutical Asses

Family

Problems

Procedures

Medications

Laboratory Test

Document

Pharmaceutical Asses

Family

Problems

Procedures

Medications

Laboratory Test

Document

Pharmaceutical Asses

Family

Clinical Photo

Save Task Reset Cancel

CIMS Feature: Link to Body Chart

39

Department of Health
The Government of the Hong Kong Special Administrative Region

9111100001 Cheung Bo Bo 張寶寶

Body Chart

Wart

Back Chart

Save Task Reset Cancel

CIMS Feature: e-Form Deployment

40

Adobe Acrobat
Document

CIMS Feature: Periodontal Chart - General

41

By pressing display the

Tooth marked in grey colour means it is an implanted tooth.

Tooth marked with 'NC' means it is a non-charted tooth.

Tooth marked with a red cross means that the tooth has been removed.

Dental Peri Chart

General Peri

Snapshot

CIMS Feature: Periodontal Chart - Pocket 1

42

To chart the pocket depth of a tooth, user can simply click on the corresponding input box in the 'Pocket' row.

Dental Peri Chart

Pocket

CIMS Feature: Periodontal Chart - Pocket 2

43

Once user clicks on an input box, a series of numbered buttons will be shown.

CIMS Feature: Periodontal Chart - Pocket 3

44

User may skip an input box by pressing the [N] button.

To capture the pocket depth, user can either click on the appropriate numbered button using a mouse, or directly input the number using a keyboard.

The System will automatically move onto the next input box whenever a reading has been captured to facilitate user's input. The movement direction can be defined by the user.

CIMS Feature: Periodontal Chart - Bleeding

45

To represent a bleeding condition, user can click on the [Bleeding] button.

And then click on the relevant input box(es), the colour of that particular input box(es) will turn into pink.

CIMS Feature: Periodontal Chart - Mobility 1

46

To chart the mobility of a tooth, user can simply click on an input box in the 'M' row.

CIMS Feature: Periodontal Chart - Mobility 2

47

User can first capture the Electric Pulp Tester (EPT) (+ve or -ve) and the class of mobility for that particular tooth.

And then user may capture the furcation information by selecting the solid or hollow triangles and apply on specific region diagram.

Once the user clicks on an input box, the mobility related options will be shown.

User may also keep the mobility information as 'Non-Charted' by checking the box here.

Finally user can press [Confirm] button to complete the capture or [Reset] button to start from the beginning.

CIMS Feature: Periodontal Chart - Mobility 3

48

Once user confirms everything, the mobility information will be shown in the chart.

CIMS Feature: Periodontal Chart - Recession 1

49

To chart the recession of a tooth, user can simply click on an input box in the 'Rec' row.

CIMS Feature: Periodontal Chart - Recession 2

50

Similar to pocket capturing, once user clicks on an input box, a series of numbered buttons will be shown but in different range as compared with those in pocket.

CIMS Feature: Periodontal Chart - Recession 3

51

Similar to capturing pocket data, user can either click on a numbered button using a mouse, or directly input the number using a keyboard to capture the recession reading. The System will automatically move onto next input box whenever a reading has been captured. The movement direction can be defined by user.

CIMS Feature: Periodontal Chart - Snapshot 1

52

User can make use of the [Snapshot] button to take a still image of the chart for reference.

CIMS Feature: Periodontal Chart - Snapshot 2

53

This pop-up window will be shown whenever the [Snapshot] button is clicked.

This area serves to capture any clinical notes in textual format for this captured image.

This check box allows user to indicate whether this captured image will be deleted according to the defined housekeeping rules or not.

Automatically delete

Confirm Cancel

CIMS Feature: Periodontal Chart - Snapshot 3

54

Once user saves the still image, the date of capture will be shown on the timeline. User can recall the image by clicking on the date mark and view the inputted clinical notes as tooltip.

Thank you